

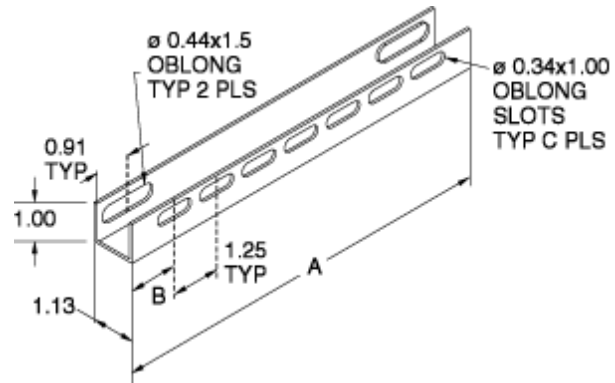

Quality Products. Service Excellence.

Eclipse DIN Rail Mounting Kit *DRMK Series*

- Field installable.
- Mounts directly to panel collar studs (panel not required).
- Accepts optional DIN rails.
- DIN rails available separately.
- Zinc plated, yellow dichromate.



Part No.	Length
2DMK12	10.00
2DMK16	14.00
2DMK20	18.00
2DMK24	22.00
2DMK30	28.00

Tags: DIN, DIN rail, mount kit, Eclipse

Data subject to change without notice

© 2026. Hammond Manufacturing Ltd. All rights reserved.